

FEATURES

- 2-Digit LED display.
- 4 LED status indicators.
- Preact function.
- Preset maximum limit.
- Missing pulse detection.
- Variable doserate selection in direct millilitres / cubic metres.
- Display counts in selected predosed cubic metres of concrete
- Optional PLC and computer interface.



The ME995-2CS VARIABLE DOSERATE CUBIC METRE preset batch controllers are used for dosing admixtures to comply with quality assurance requirements for the concrete additives industry. The display counts in total pre-dosed KGs. It can be used with MES20, AMM20, 1 millilitre per 1 pulse output flowmeters. (1000ppl), for preset liquid batch control applications.

The controller incorporates a preact (overflow deduct) feature, 4 LED status indicators and diagnostic safeties. The ME995-2CS Batch Controller uses a new Dinkle 10-pin screw terminal connector plug, replacing the obsolete 10-pin Weidmuller receptacle plug as the previous models, The pinout is the same, minimizing changeover reviewing time as much as possible. It can be easily interfaced with PLCs, thus incorporating the controller's safety features and providing a backup batch facility.

The **ME995-2CS** calculates selected dosage rates for the batch operator. The three top selector knobs are for dosage selection of liquid admixture to be dispensed, marked DOSAGE MLS / CUBIC METRE. A maximum doserate of 990 millilitres per Cubic Metre is selectable (Note: The first selector knob is stationary and is locked at zero (0). The two bottom selectors are used for selection of CUBIC METRE concrete quantity. Maximum load is 9.0 CUBIC METRES (minimum is 0.1). The LED display digits count upward to the selected load in cubic metres, while dispensing the selected dosage rate ratio.

WARNING: With the ME995-2CS model, dosage is selected in direct Millilitres (MLS) as opposed to the standard ME995-2C where the dosage is selected in Millilitres (MLS) x 10 / Cubic metre.

A batch example would be:

- Selected dosage rate **250 mls/cubic metre**
- Selected Cubic metre cement load of **2.0 cubic metres**
- Actual admixture volume received 250 mls x 2.0 = 500 millilitres.
- Display counts upward in 0.1 Cubic metre increments to set point of final 2.0

The controller operates from standard 220 - 240 VAC (or optional 110 VAC or 12 - 24 VDC) voltage supplies. Contact output drive is via one (or optional two) relays. Standard controllers are in panel mount form, or optionally can be housed in a metal box or IP65 ABS wall mount enclosure.

The ME995-2CS controller is designed for compatibility with MES20, AMM20 , 1 millilitre per 1 pulse output flowmeters. (1000ppl)



WARNING



- This product is intended to and must be used in a housing enclosure or panel mount in accordance with the relevant safety standards.
- The ME995-2CS must not be used on a freestanding on a desktop surface as there is a risk of electric shock from exposed high voltage AC.
 - Disconnect main supply before opening unit or performing cleaning and maintenance.

PLEASE READ INSTALLATION, MAINTENANCE AND OPERATING INSTRUCTIONS BEFORE USE. IF THIS EQUIPMENT IS USED IN A MANNER NOT SPECIFIED IN THIS MANUAL, THE PROTECTION PROVIDED BY THE EQUIPMENT MAY BE IMPAIRED.

BATCH PROTECTION FEATURES

ME995-2CS

- * **LIMIT (LM) LED** activates if batch cycle reaches locked internal limit or if circuit diagnostics detect internal chip problem. There is subsequent automatic shutoff of voltage contact drive.
- * **PULSE FAIL (PF) LED** activates if no pulses arrive within 1.5 seconds (variable) initial start time period, or if pulses are interrupted during batch cycle and fall below (variable) pulse scanning time (typical 25Hz). There is subsequent automatic shutoff of voltage contact drive output.
- * **FLOW (FL) LED** monitors and indicates incoming pulses from field flowmeter, or if TEST is used.
- * **CONTACT DRIVE (CD) LED** indicates voltage contact output drive when pump or solenoid are activated.
- * Internal audible **ALARM** sounds momentarily upon completion of batch cycle, and continuously if PULSE FAIL or LIMIT LEDs are activated or if overflow runs 250 millilitres over selected batch quantity.

INSTALLATION AND MAINTAINANCE INSTRUCTIONS

ME995-2CS

INSTALLATION

1. Please disconnect all mains supply before proceeding with Installation.
2. Connect wiring as per the wiring examples for the device.
3. Mount the device in a panel housing such as the SHB or SHB1, otherwise in accordance with the relevant safety standards for laboratory equipment in industrial environments.
4. Do not mount the unit in such a way that will impede the on off switch on the ME995 unit which is used to disconnect device from mains power.
5. Do not remove any connections to the Earthing terminals in the unit.
6. If you are using your own panel housing and mains cabling. Only use a mains cabling that has an earth connection. Make sure you connect the earth to the earth terminal pin symbol on the Dinkle connector of the unit. This is shown in wiring examples below.
7. Ensure unit is mounted properly in the panel housing before connecting mains power.
8. Refer to operating instructions.

MAINTAINANCE

If the device is not turning on indicated by light on the LCD display, then do the following:

1. Please disconnect all mains supply before proceeding with Removal of ME995 unit from Panel housing.
2. Remove the device with a Philips screwdriver on either side of the panel.
3. If the device is not working inspect the fuse, by removing the fuse holder with a flat screwdriver. Replace fuse with only a M205 F1.5A rated fuse and type.
4. Replace the device in the panel using the screws before turning on the main power.
5. Should the device still not operate please contact ManuFlo support.

CLEANING

1. Please disconnect all mains supply before proceeding.
2. Clean the device with a cloth and damp with isopropyl alcohol.

- * To operate, push each of the toggle switches ON-OFF, START-STOP and TEST-RESET to the desired function.
- * Switch the power ON to unit. Select required batch quantity using rotary number dial selector switches.
- * RESET unit. The LED displays zero and all LED indicators and alarm turns off. The unit is ready for batching.
- * START unit; voltage contact drive activates. CONTACT DRIVE LED illuminates indicating pump or solenoid are energized, followed by FLOW LED illuminating, indicating pulsing and operation of flowmeter. The digits begin counting upward towards the selected batch quantity.
- * Upon digits reaching the selected batch quantity the alarm sounds (short beep) indicating completion of batch; CONTACT DRIVE and FLOW LEDs turn off. LED display digits and selected batch quantity should correspond. If LED digits overshoot target, use PREACT (inflight, freefall) overflow deduct dials (located at rear of controller unit) to scale back the difference.
- * To interrupt unit before completion of batch, push STOP toggle; digit counting will stop, drive contact off. Push START toggle to resume batch.
- * TEST toggle is used to test digit counting, switch contacts, alarm conditions or generate output pulses for computer interfacing. TEST does not activate pump or solenoid.

Warning: if CONTACT or FLOW LED indicators are on, but controller is not counting, discontinue use and call for service.

PREACT: Calibrating inflight overflow is via two rotary select knobs marked "HUNDREDS" and "TENS" of MILLILITRES, located at the rear of controller. Simply set knobs to same overflow reading as indicated by the LED display.

Example: 5.0 Cubic metres, but at completion of batch displays 5.1 Cubic metres. Then set the preact knobs to hundreds=0 & tens=1.

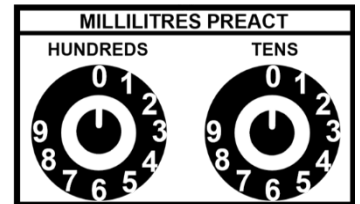

SPECIFICATIONS

ME995-2CS

Power supply	220-240 VAC @ 50 Hz Input current: <ul style="list-style-type: none"> • Typical: 100mA • Maximum: 8.3A (Using SHB1 at maximum load) (Optional 110 VAC or 12-24 VDC units)
Output to flowmeter	12 VDC upto 100mA
Relay outputs	Max. 240 vac, 1 A. SHB1 model: 240VAC socket drive to pump maximum load 1800W. Other outputs on request.
Frequency input	5 KHz: x1 input (fixed for 1ml./1pulse flowmeter only)
Display	2 digits, 7 segment LED (14mm H)
Connection	10 pin Dinkle mating plug & socket
Fuse	1.5 Amp (5 x 20mm case)
Batch selection	Visual rotary select switches
Batch commands	Push toggle switches
Mounting	Panel mount
Instrument housing	ABS hi-impact case mould
External dimensions	206 L, 130 H, 90 D mm
Panel cutout	190 L, 122 H mm
Weight	1 kg
Sound	80dB at 10cm
Environmental	5 – 40 Degrees Celsius
Usage	0% to 75% relative humidity Up to 2000m Altitude Pollution Degree 1 Indoor Use (air is not significantly polluted by dust, oil, or chemicals)





Due to continuous product improvement, specifications are subject to change without notice.

ME995-2CS Batch Controller, 240 vac supply and output, with 12 VDC power to flowmeter (standard).

Options:

Code	Description	Code	Description
-DC-OC	12-24 VDC power supply input/output drive, with Open Contact output drive (5 A) which is via external voltages	-5P	5-pin computer interface plug (start, stop, reset, pulse,+12V) for use with ME5IC interface card for Jone1, COMMANDbatch etc PLCs.
-24VAC	24 VAC powered and output.	-MC	4-pin PLC/Computer Command (Start/Stop/Reset) interface plug.
-110	110 VAC powered and output.	-MC2	<ul style="list-style-type: none"> • 2-pin plug for scaled 4N33 open collector pulse output (1 pulse/ 1 Litre). • Includes 4-pin external command (Start/Stop/Reset) interface plug.
-OC	Open Contact pump/valve output, for use with any driving voltage (maximum 5A current).	-MC2-C	Compubatch interface: 2-pin plug with OPTO 4N33 pulse output. Includes 4-pin external command (Start/Stop/Reset) plug.
-A0	Contact output: alarm/batch-complete voltage relay or logic state	-SSRBC	External command: Start/Stop/Reset, for connection to HB2500-SSR housing box, or for remote control facility.
		-S12	switch: two product changeover output drive. Allows 2 flowmeter-inputs/pump-drives.

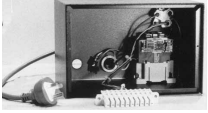
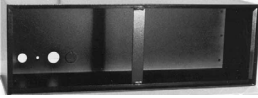
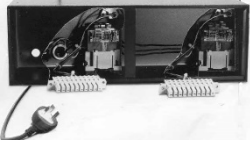
e.g. "ME995-2CS" is the standard Batch Controller, 240VAC powered, without any of the options, whereas "ME995-2CS-MC2" is an ME995-2CS Batch Controller with a scaled open collector pulse output, and a Start/Stop/Reset computer interface.

SHB	Single enclosure. Powder coated metal.		
SHB1	Single enclosure. Powder coated metal. Wired with 240vac contactor (for 1 hp pump), plug-in 240 vac pump outlet and plug. Contactor and plug rating at 10A.	<i>SHB</i>	<i>SHB1</i>
SHB1-T	as for SHB1 above, but with terminal wiring entry connection instead of 240vac pump outlet Contactor and plug rating at 10A.		
DHB	Dual enclosure. Powder coated metal.		
DHB2	Dual enclosure. Powder coated metal. Wired with 2x 240vac contactors, 2x pump outlets, and 2x plugs for Batch Controllers. Contactors and plug rating at 10A.	<i>DHB</i>	<i>DHB2</i>
DHB2-T	as for DHB2, but with terminal wiring entry connections (instead of mains lead and pump outlets). Contactors and plug rating at 10A.		
HB2510	IP65 waterproof single enclosure.		<i>HB2510-SSR IP65 enclosure shown with ME3000 Batch Controller</i>
-SSR	External commands: Start/Stop/Reset. IP65 rated (option fitted to HB2510).		
-C240W	240VAC contactor, internally wired. To drive pump. 4.4kW (up to 8.8kW on request) Contactor rating at 10A		



WARNING



- This product is intended to and must be used in a housing enclosure or panel mount in accordance with the relevant safety standards.
- The ME995-2CS must not be used on a freestanding on a desktop surface as there is a risk of electric shock from exposed high voltage AC.
 - Disconnect main supply before opening unit or performing cleaning and maintenance.

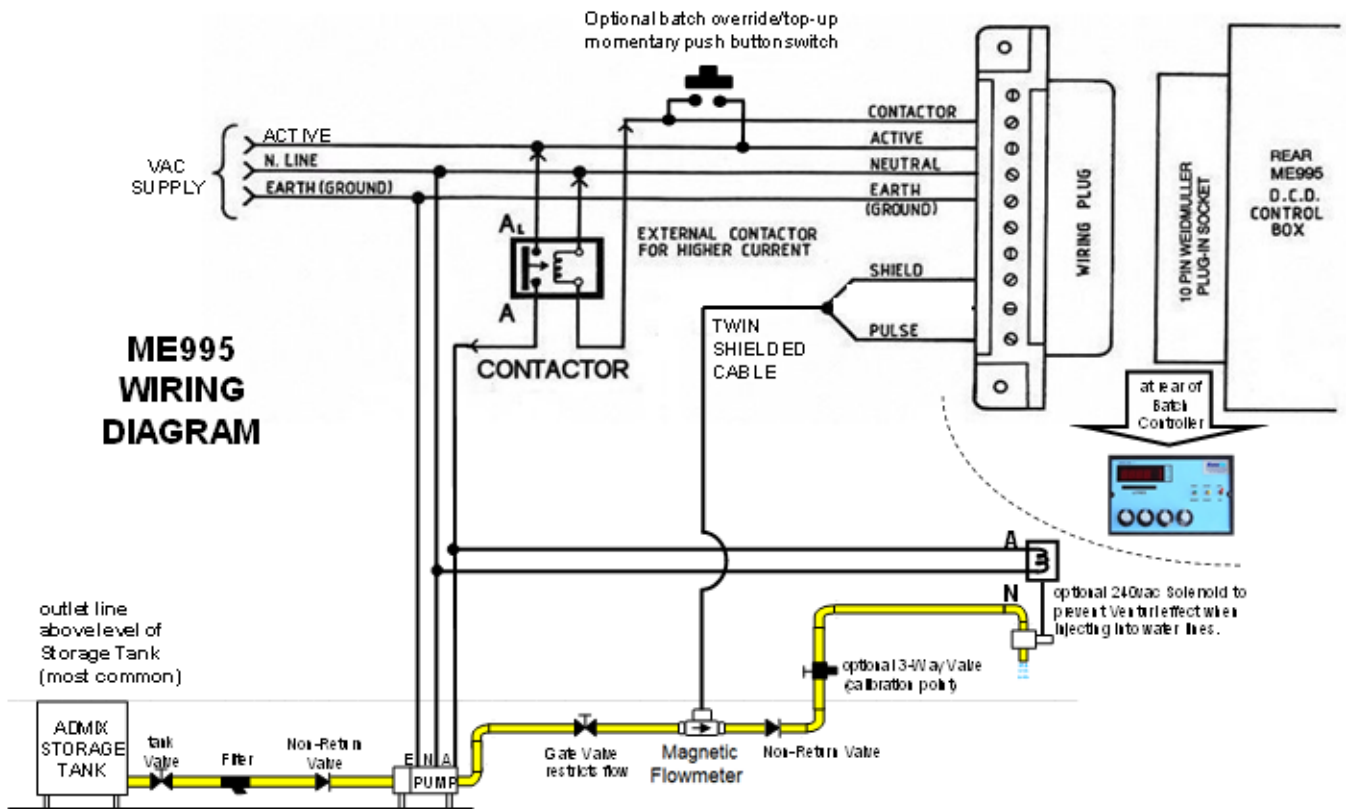

Standard AC Wiring for Pump and optional Solenoid

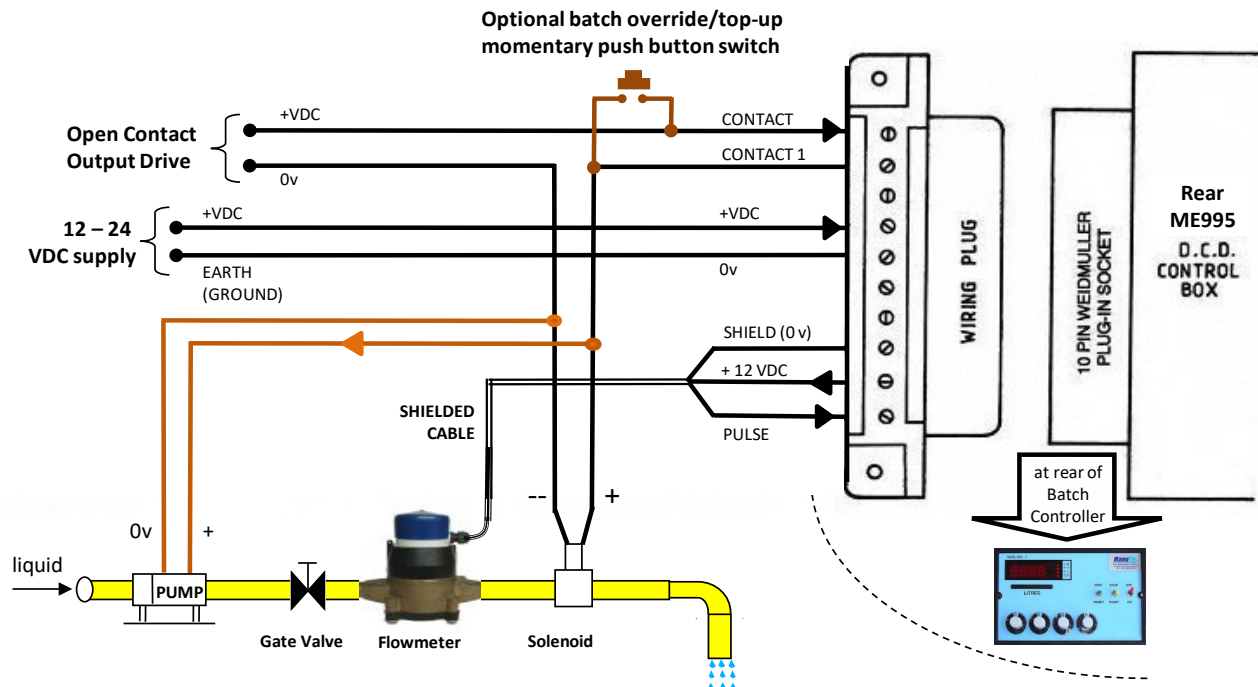

Wiring for DC-powered Batch Controller with DC Open Contact Output Drive to Pump and/or Solenoid

NOTE: if current draw of solenoid is > 0.5 Amps, or if using a pump, then install a contactor