

LATEST FEATURES

- 4 digit large LCD resettable totalizer (20mm high digits)
- Total displayed in Litres (with optional 1 decimal place)
- *Premium ASA* (acrylonitrile styrene acrylate) high impact, high UV resistant IP65 Display Housing
- LCD viewing window with 3M film scratch protection.
- Dual Hinged robust lid protects LCD from sunlight, with magnetic flip lid reset of total.
- Slip insertion sensor design with locking cap allows simple removal from pipeline if cleaning rotor.
- Easy Access for re-calibration and smart 1 point re-calibration function.
- Optional External re-calibrate via Portable Device with RFID calibration software via NFC Android.

OPTION:

- **Pulse Output** – 1 Pulse/1 Litre or 1 Pulse/0.1 Litre (passive pulse output via IP67 plug set).

STANDARD FEATURES:

- Custom designed and built primarily for use on Concrete Transit Mixers.
- Unaffected by water hammer, compressed air, mild frozen or light recycled water.
- Robust Gunmetal flowtube and ABS display housing for the harshest environments.
- Durable alloy paddlewheel rotor.
- Sealed IP65 digital display compartment.
- Hinged cover protects LCD from sunlight.
- Easy access for re-calibration.
- No damage to meter if operated outside its flow range.
- No filters needed prior to meter.
- ± 2% accuracy flow curve, with calibration certificate issued



New ASA industrial Display Enclosure



The **MRT20-T2 resettable counter** is designed and manufactured by ManuFlo for use on mobile concrete transit truck mixers (agitators). Constructed of tough materials, the MRT20-T2 can withstand the abuses experienced in the premix concrete industry. The gun-metal pipe flow-tube has 20mm (¾”) BSP male threaded ends **and is fully interchangeable with its predecessor the MRP20-T2 retaining the same flow tube insertion length.**

The MRT20-T2 flowmeter is suitable for general medium to high flow range water flow measurement applications. Being internally Lithium battery powered, it is ideal in situations where no external power supply is accessible, making it a totally portable flowmeter. A pulse output is optionally available for logging and remote GSM tracking applications.

The self-contained LCD counter, registers flow in total Litres. The only moving part is an alloy rotor which turns as liquid flows past it. The high impact ASA lid protects the LCD and front cover from prolonged sun exposure, contaminants and breakage.

To operate, lift the hinged lid twice (some models once). This action automatically turns on power and the Liquid Crystal display is zeroed ready for measurement. Liquid flow causes counting on the display and closing the lid resets the digits. The internal lithium battery has a typical life of 10+ years. NOTE: A sleep mode function turns the display off after 5 minutes of no use. The display is re-awakened either by flow occurring or by closing and re-opening the lid.

TECHNICAL DATA

MRT20-T2

SPECIFICATIONS	
Flow Range	8 to 100 Litres/minute
Accuracy	± 2% accuracy (at 0.7 – 8 m/s flow velocity).
Display Readout	Counter: 4 digit in Litres (L) 20 H x 8 W (mm)
Power Source	3.6V Lithium battery (typically 10+ year life)
Display housing rating	IP65 water resistant
Max. operating temperature	50 °C
Max. operating pressure	1100 kPa
Dimensions (mm)	272 L x 120 H x 84 W (mm)
Pipe Connection	20mm ¾”Bsp-m threaded.
Weight (max)	1 kg
Pulse output option	1 Litre/pulse or 0.1 Litre/pulse @>5 milliseconds width Via M12 IP67 plug set with 5m lead.



Meter flow tube	Gunmetal
Meter display housing	ASA-UV & 316 SST Screws (x4)
LCD Window	3M 'anti scratch' protection film)
Lock Cap	Brass or Polypropylene
Body (Shaft)	Delrin (Acetal)
O-ring x2	Neoprene (Part BS020)
Paddlewheel / Rotor	Marine alloy with Delrin bush
Axle	Tungsten Carbide

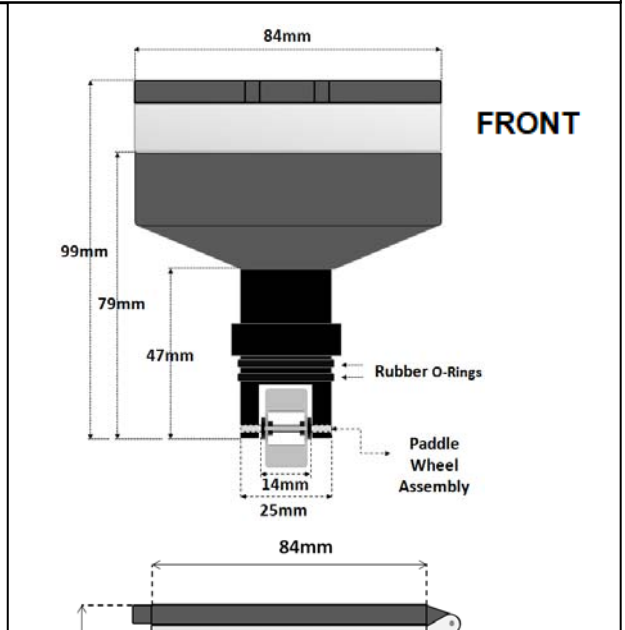
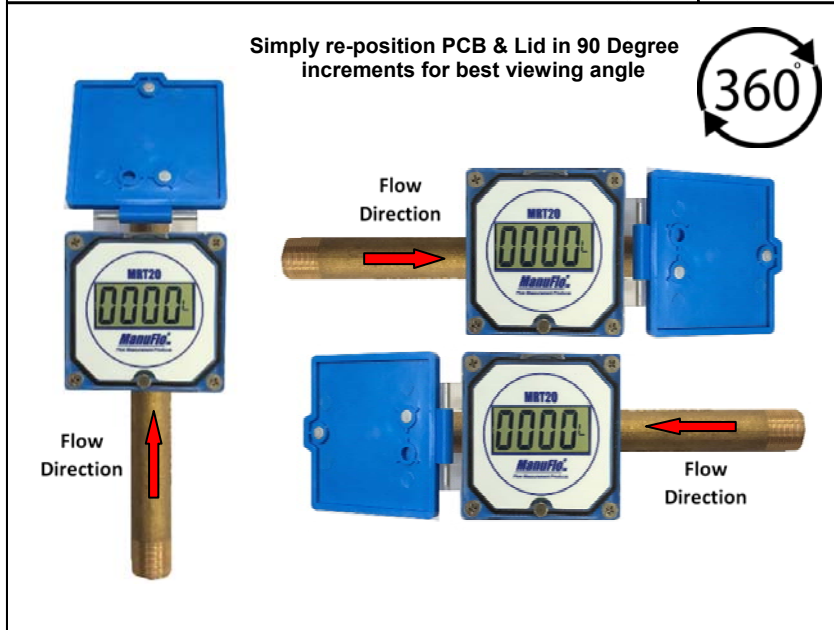
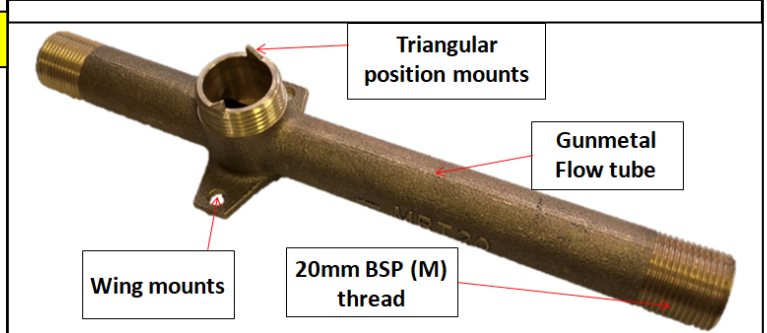
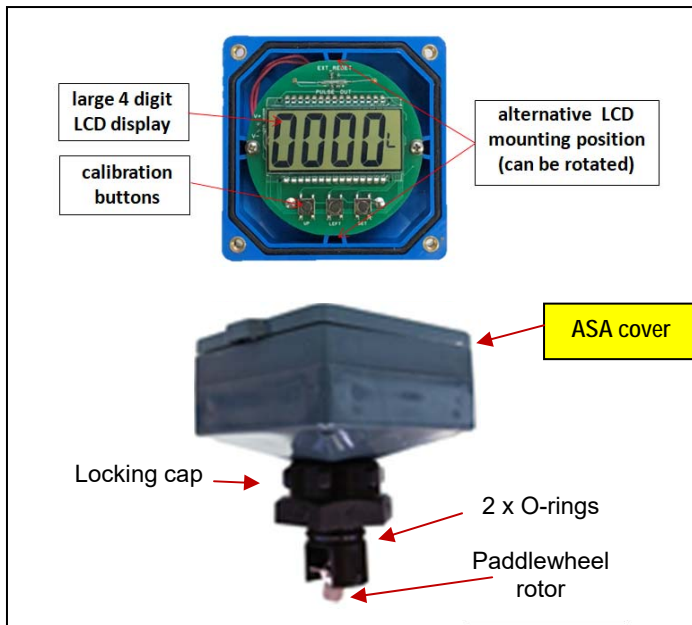
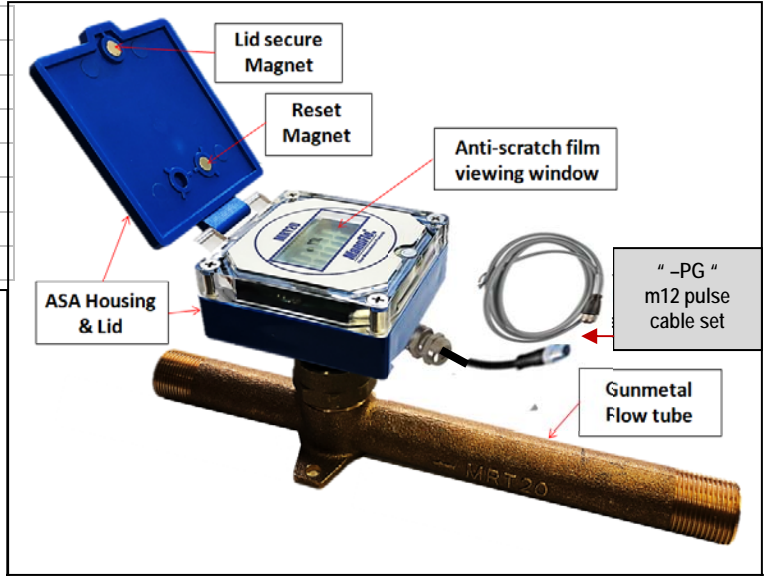

ELECTRICAL CONNECTION DATA

For "-PG" M12 4pin pulse plug lead coming from MRT20 flowmeter:-

1 Litre/pulse => 5millisec. width open collector
N-Channel MOSFET, 5-30VDC 1 Amp Max

Note: Standard ASA material colour issue is now Grey

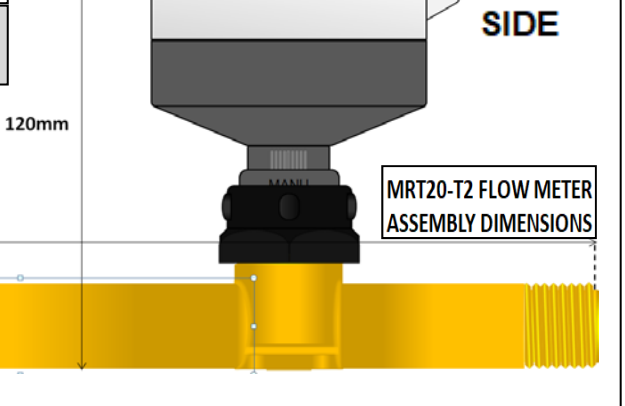

1. MRT20-T2 flowmeters are factory calibrated for vertical (upwards) mounting flow run. If mounting contrary to the factory set calibration, you may need to access the internal electronic circuit board to change calibration setting (via 3 internally located pushbuttons). Refer to 'Re-Calibration' section later in this datasheet.
2. Body flow tube ends are 20mm (¾") BSP (male) thread.
On each side of the flowtube housing, there are wing mounts with 1/4" drill holes for mounting to a structure.
3. The flowmeter must measure in a full line of liquid. Valves can be fitted before or after the flowmeter.
4. Close lid after use to prevent the LCD fading due to prolonged exposure from direct sunlight.

MAINTENANCE

Recommended Periodic Checks:

With clean liquids, sensor check of the paddle wheel is recommended once every year.

Removal of MRT20 from the pipe adaptor flow tube, as follows:

- 1 - Unscrew the locking nut (anti-clockwise).
- 2 - Hold the neck of the Tee piece in your left hand grasp the enclosure with your right hand and turn slowly **anti-clockwise** until the sensor pops out of slot then pull upwards out of socket (refer picture).

**When returning the sensor to nipple adaptor insert so the keyway and slots line up then push down until they locate. Screw the brass or polypropylene lock nut clockwise to hold the sensor in place, secure with large spanner or monkey wrench do not over tighten.

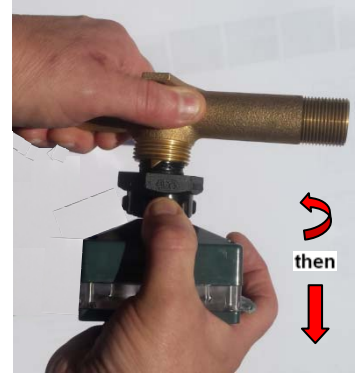

RE-CALIBRATION

Recalibration is performed via three internal pushbuttons (marked SET, LEFT and UP) mounted on the PCB. To access the PCB, buttons, open the hinged lid and remove the four SST screws holding the viewing window to the enclosure. Set the viewing window aside in a safe place you will now be able to see the green PCB and the programming buttons.



Adjusting the Calibration Value using the 'Volumetric' Method





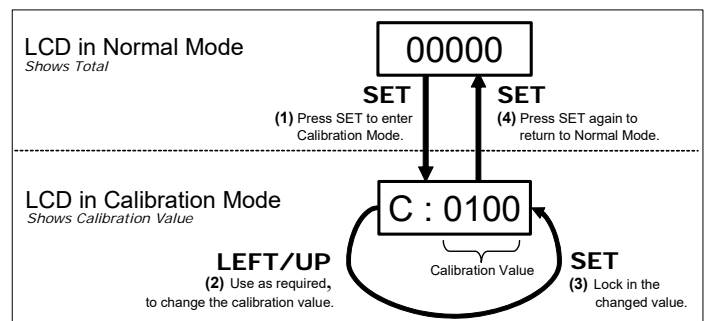

- Run liquid through the MRT20 into a calibrated vessel or load cell, until at least 50 Litres is displayed on the screen. For accuracy, keep flowrate continuous and above 10 Litres/minute.
- Compare the actual amount collected against what is displayed on the MRT20. If the amount collected matches the amount displayed within ±2%, then no adjustment to calibration is necessary.
- **Formula:** $Percentage\ error = (Amount\ displayed - Amount\ collected) / Amount\ displayed \times 100$
- If the amount collected is less than that displayed, say only 45 Litres, yet the display shows 50 litres, this is 5 litres under or 10% (i.e. 5/50x100%). So, increase the set calibration value by 10% e.g. if set to 100, new value is 100 + 10% = 100 + 10 = 110.
- If the amount collected is more than that displayed, then decrease the calibration value e.g. if the amount collected is say 55 Litres, yet the display shows 50 litres, this is 5 litres over or 10% (i.e. 5/50x100%). So, decrease the set calibration value by 10% e.g. if calibration value is set to 100, then the new value is 100 - 10% = 100 - 10 = 90.

To change the calibration value:

1. Calibration Mode is entered by pressing the SET pushbutton and the Calibration Value is then shown. Write down the displayed Calibration Value to remember it.
2. As required, use the LEFT button to select a digit to be changed (selected digit will flash), and use the UP button to change the value of the selected (flashing) digit.
3. When all required digits have been changed, pressing SET will lock in the new Calibration Value.
4. Pressing SET again will exit Calibration Mode.



Adjusting the Calibration Value using Smart 1 Point Calibration (User friendly, No calculations needed)

<p>Step 1. Press UP button for approximately 5 seconds</p> <p>LCD display in 1 point calibration mode.</p> 	<p>Step 4. (Continuation)</p> <p>Example: Volume = 20.0 Litres</p> 
<p>Step 2. Start flow (Run liquid through the MRT20)</p> <ul style="list-style-type: none"> • Calibration will automatically start upon flow detection. • Display must register at least 100 counts or more before stopping the flow. <p>Example: Display = 104 (counts)</p> 	<p>Step 5. Press SET to display Gear Rate value.</p> <p>Example: Actual pulses per Litre is Displayed (x multiplier)</p> 
<p>Step 3. Stop flow</p> <ul style="list-style-type: none"> • After flow is completely stopped, wait for approximately 10 seconds. • The display will update to allow entry of collected amount of liquid in litres. <p>LCD display, 10 seconds after flow completely stops.</p> 	<p>Example: Main display in L/M and Litres (L)</p>  <p>Note: Gear Rate value will be displayed for approximately 5 seconds then the display will automatically exits calibration mode and returns to counting mode (Main Display). This indicates that the meter has been successfully re-calibrated.</p>
<p>Step 4. Enter volume collected in Litres.</p> <ul style="list-style-type: none"> • Press LEFT button to select desired digit to be change. • Press UP button to change the value of selected digit. • Press SET to lock in the changed value. 	<p>Step 6. Verify that the meter has been properly re-calibrated.</p> <ul style="list-style-type: none"> • Do one or more test run and verify if the MRT20 displayed amount is now within $\pm 2\%$ error. • If satisfied, properly mount the viewing window and 4 screws back to its original state. • Otherwise, repeat Steps 1 to 6

ORDERING INFORMATION

Order Code	Description
MRT20-T2	20 mm Digital LCD "Litres" resettable counter flowmeter up to 50°C Gunmetal flowtube with 3/4" BSP(male) threaded both ends with slip insertion BSP keyway locator and locking cap.
-D1	Display total in LITRES to 0.1
-PG	Pulse output option (1 Litre/1 pulse), with 4pin M12 IP67 plug set 0.3mtr lead-m, 5mtr cable lead M12-f. 50 Hz maximum, 5 ms fixed pulse width. (pulse can be live even when lid is closed)
	Pulse output option (0.1 Litre/1 pulse), with M12 IP67 plug set, 5mtr cable (when unit is selected to -D1 option)
-PNL	Pulse output is Disabled when lid is closed
-NS	No Sleep mode (LCD operates continuously)

* A full compliment of spare parts are available please refer current ManuFlo price catalogue.

ManuFlo™
Flow Measurement Products

Email: sales@manuelectronics.com.au
Web: www.manuelectronics.com.au

a division of



Page 4

MANU ELECTRONICS PTY LTD

41 Carter Road, Brookvale
Sydney NSW 2100 Australia

Ph: + 61 2 9938-1425, 9905-4324
Fax: + 61 2 9938-5852